

Modul Bodenökologie WS 2013/14 :

Trophische Beziehungen

Gert Bachmann

Molekulare Systembiologie

Fakultät für Lebenswissenschaften, Universität Wien



Sektion für BODENBIOLOGIE bei der
Österreichischen bodenkundlichen Gesellschaft
Austrian Society of Soil Science

Dr. Andreas BAUMGARTEN
Spargelfeldstraße 191, A – 1226 Wien
Tel. +43 (0) 50555 34100
Fax +43 (0) 50555 34101

THERE'S TREASURE EVERYWHERE



Microhabitate im Boden

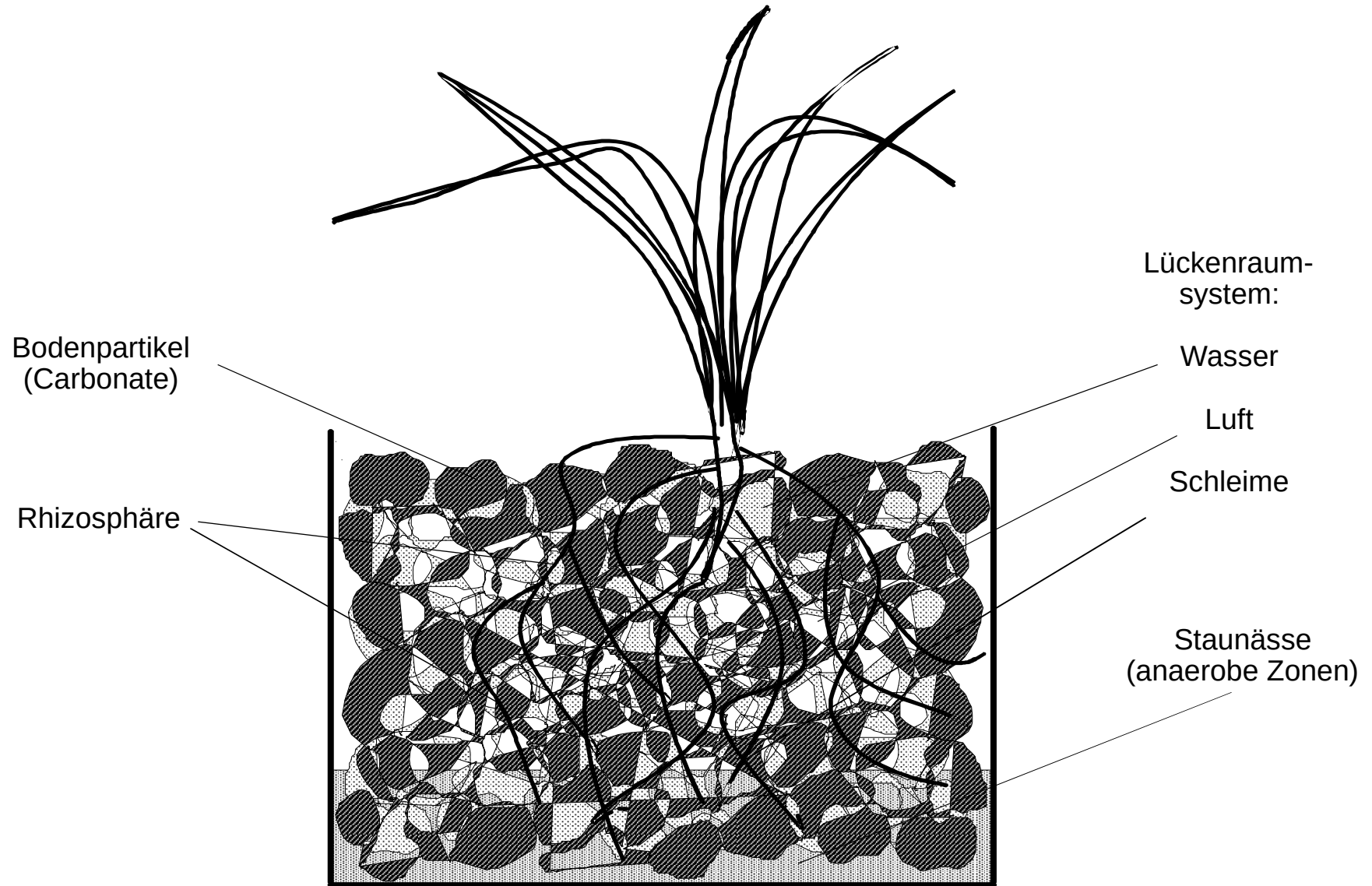

- **Die Rhizosphäre**
- Trophische Beziehungen
- Ressourcenmanagement

Lückenraumsysteme bilden Kompartimente ...

...welche sich dauernd ändern!

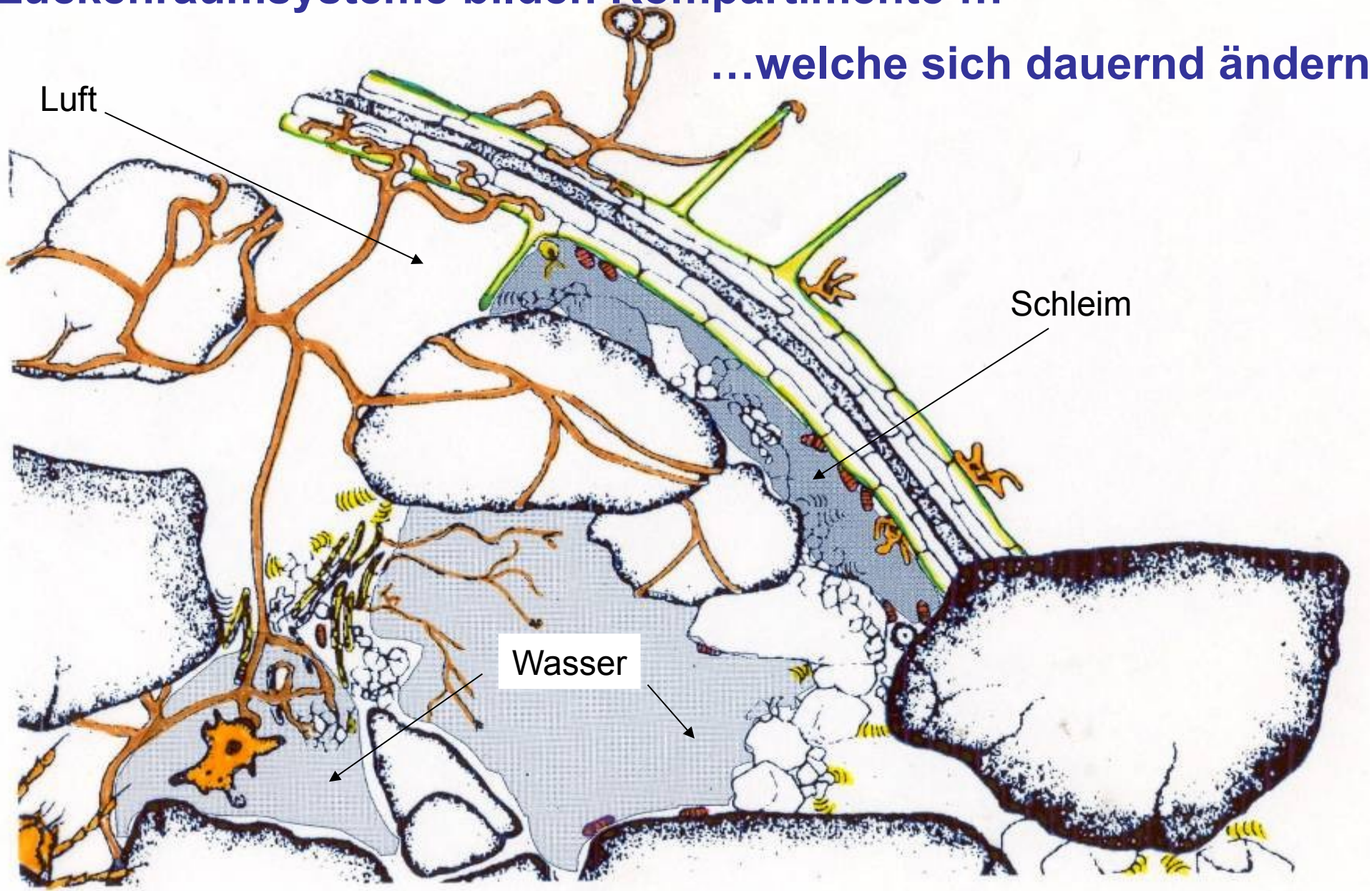

Definitionen: Bodenökologie, Bioaktivität

Bodenökologie

Rhizosphäre	Durchwurzelter Bodenraum, s.s. von der Wurzel direkt beeinflusster Boden.
Rhizoplane	Wurzeloberfläche, von Organismen besiedelt.
Rhizospährenorganismen	An der Wurzeloberfläche lebende Organismen.
Rhizodeposition	Deposition organischer fester und gelöster Substanz durch Wurzeln.
Wurzelexudation	Sekretion gelöster organischer Substanz durch die Wurzel.
Bioaktivität	Aktuelle meßbare metabolische Aktivität lebender Organismen oder Exoenzyme.
Biomasse	In g oder g C angegebene Masse lebender oder in Lysis befindlicher Organismen.
Potentielle Bioaktivität	Maximale induzierbare Bioaktivität.
Abundanz	Häufigkeit der Individuen einer Art.
Artenreichtum	Artenanzahl in einem System „species richness“
Diversität	relative Anzahl vorhandener Arten bezogen auf....(Shannon Weaner u.v.a.m.)
Relative Bedeutung	Dominanz einzelner Arten bezogen auf Abundanz und Bioaktivität.
Poolgrößen	Mengen einzelner Metaboliten .
Flüsse	Umsatzraten einzelner Metaboliten.
Energiefluss	Translokation Potetieller Chemische Energie wie etwa ATP.
Materialfluss	Translokation von Substanz, s.s. potentieller Biosubstrate.
Residenzzeit	Verweilzeit einer Substanz in einem System.
Turnoverzeit	Zeitraum der vollständigen Rezyklierung einer Substanz in einem System.
Source_Quelle	Energie bzw. Kohlenstoffquelle
Sink_Senke	Ort, an dem eine Substanz bzw. Energie immobilisiert wird.

Basisinteraktionen, mechanistischer Ansatz

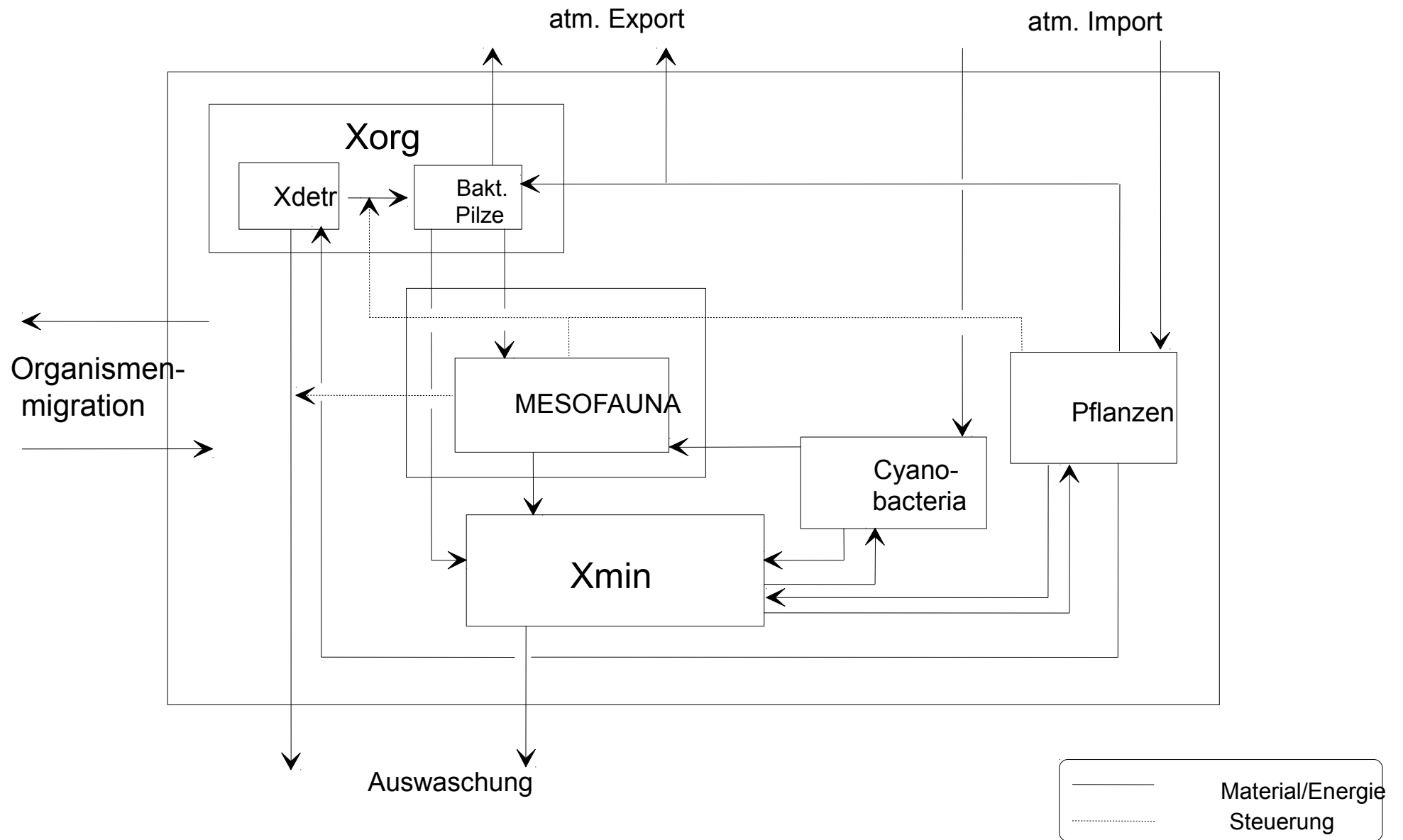

Destruenten, Detritivoren (Decomposers)



Level of Impact

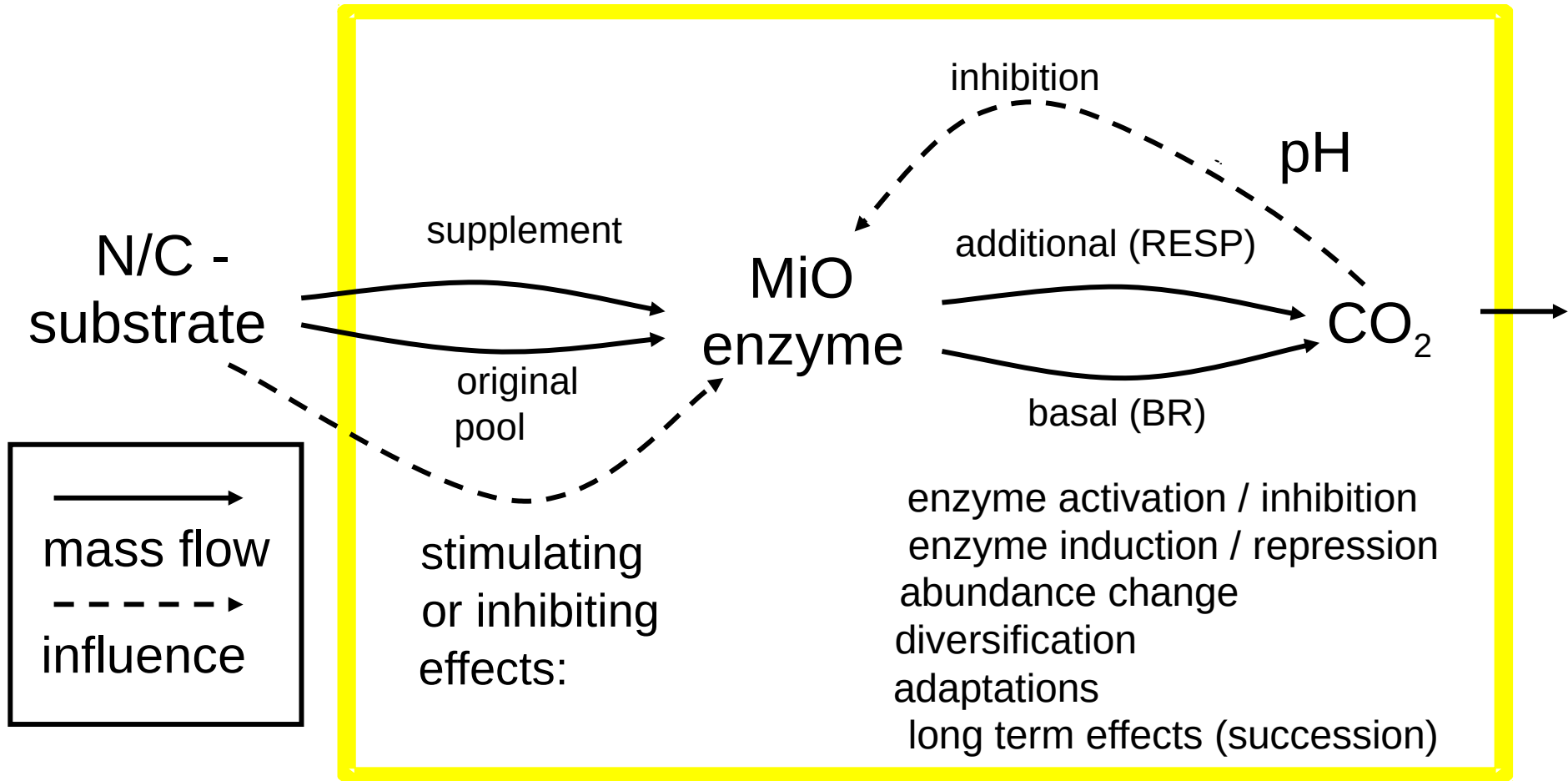

investigated system

- Die Rhizosphäre
- **Trophische Beziehungen**
- Ressourcenmanagement

Der Stickstoffkreislauf im Ökosystem

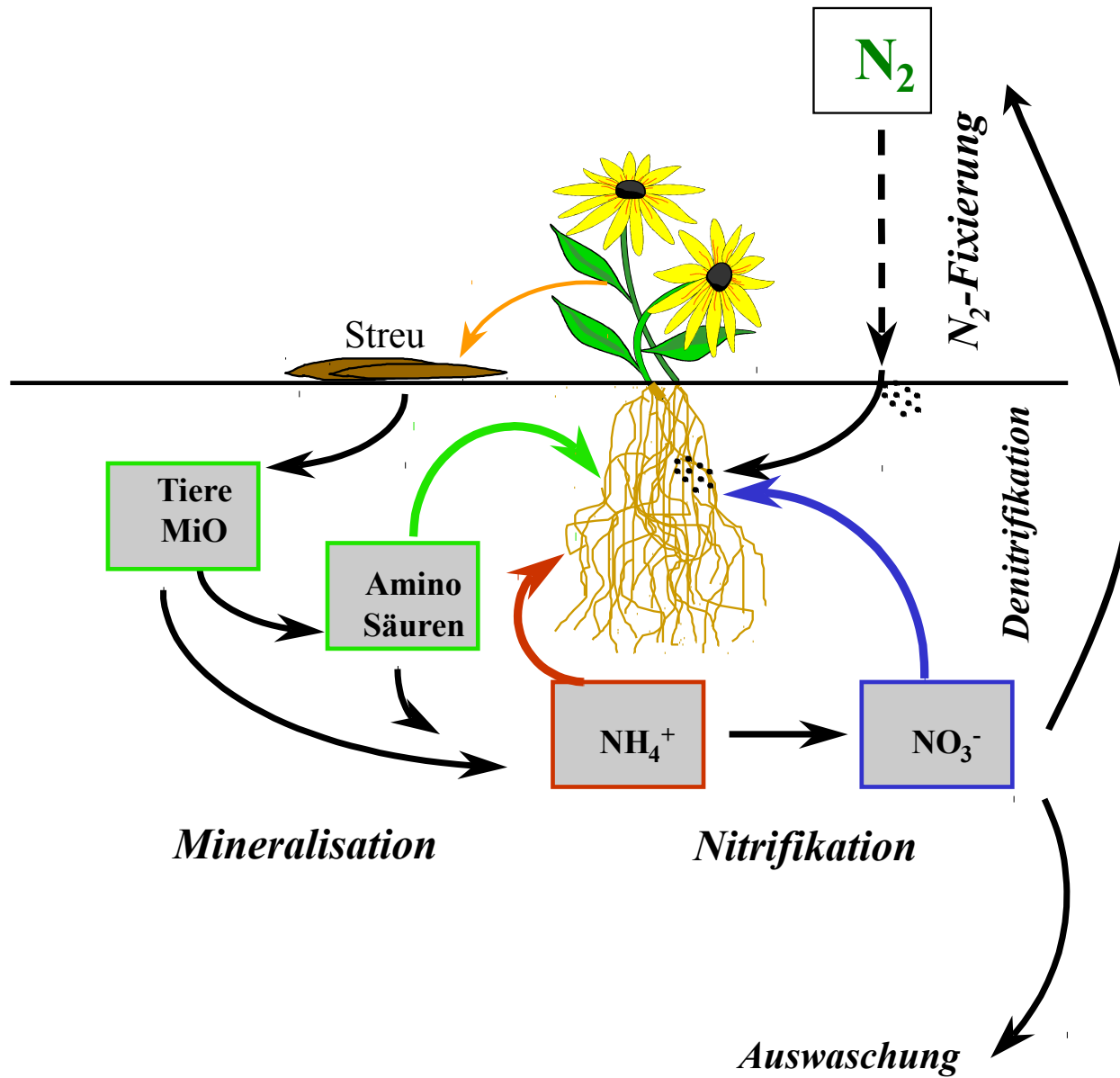

The Soil Food Web

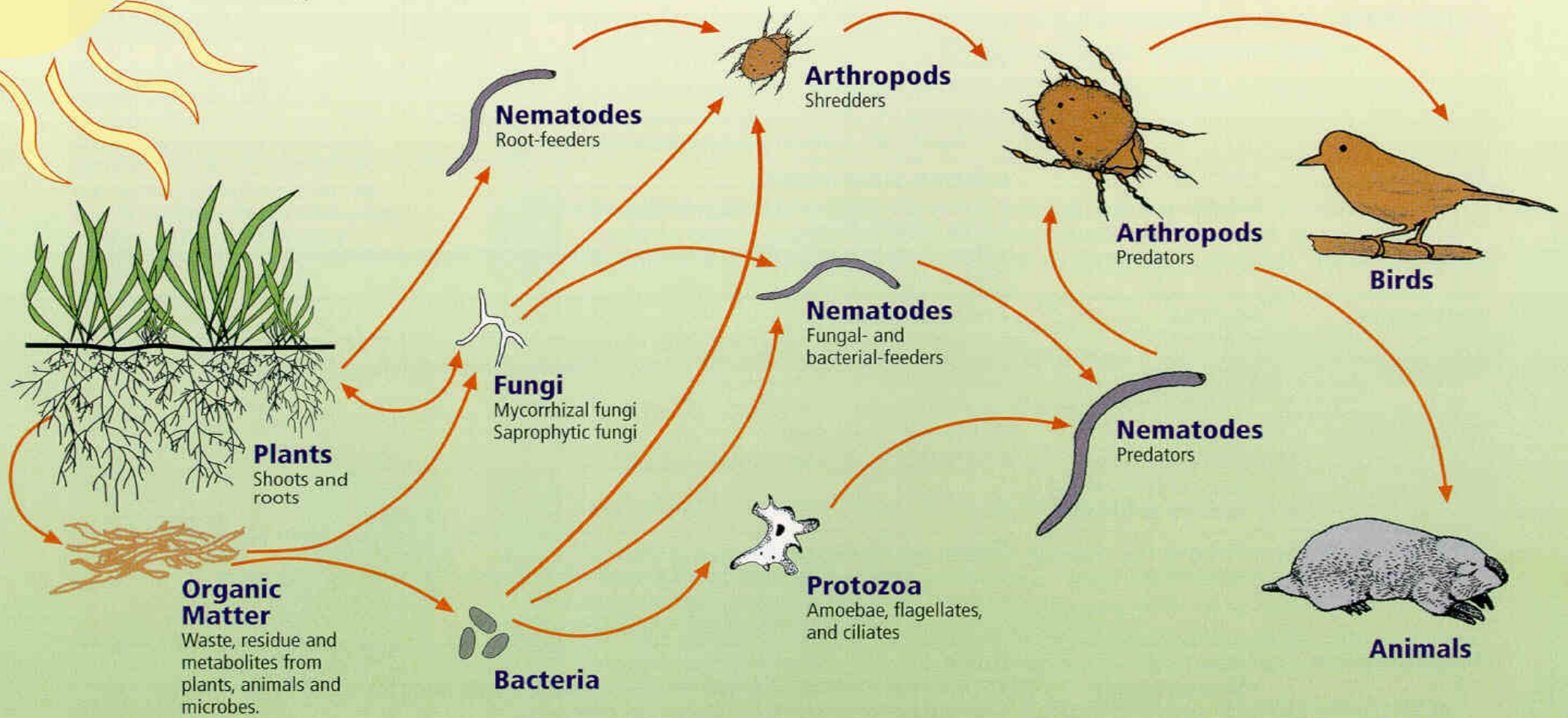

First trophic level:
Photosynthesizers

Second trophic level:
Decomposers
Mutualists
Pathogens, parasites
Root-feeders

Third trophic level:
Shredders
Predators
Grazers

Fourth trophic level:
Higher level predators

Fifth and higher trophic levels:
Higher level predators

Trophische Interaktionen im Boden

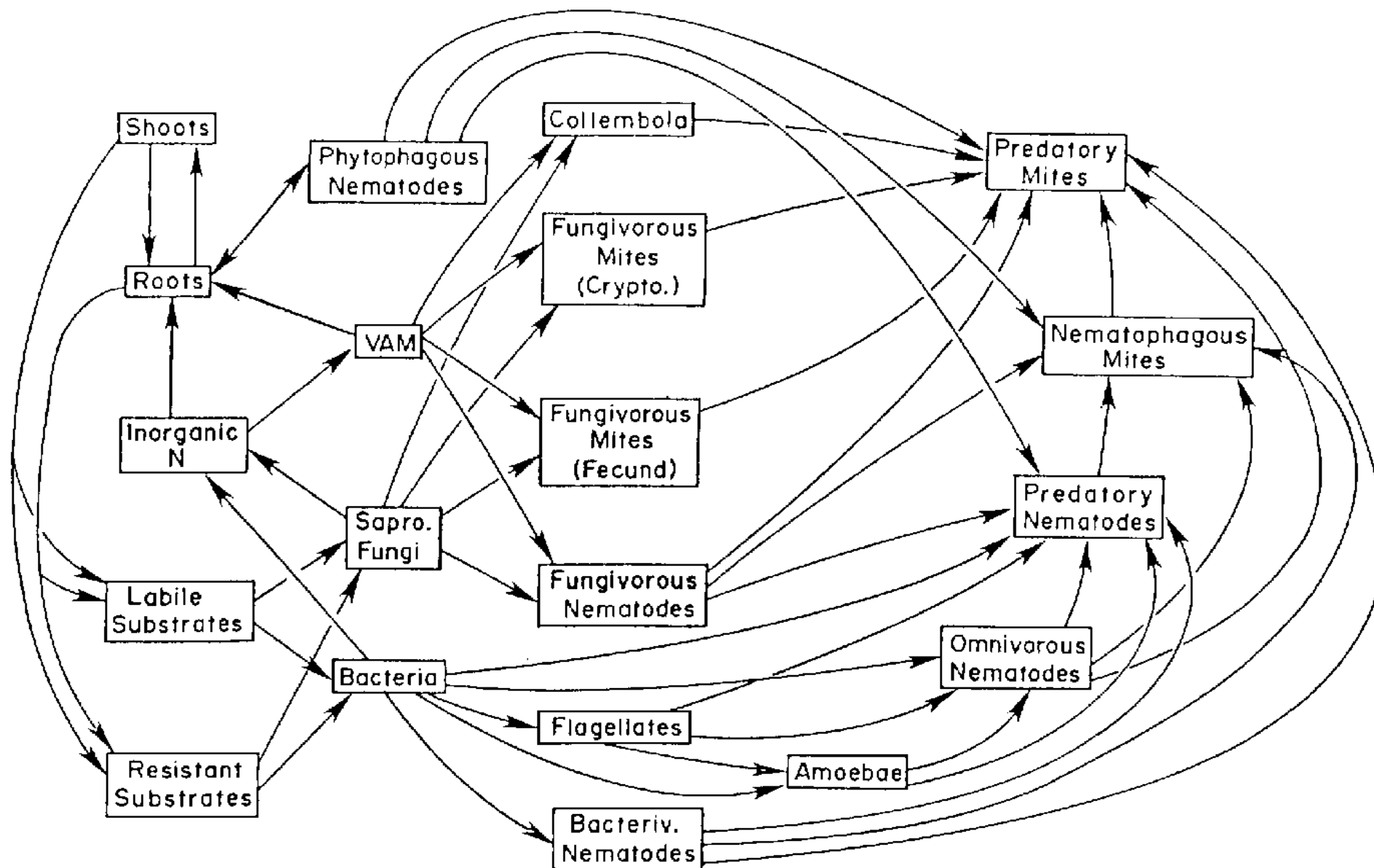
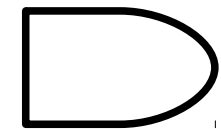
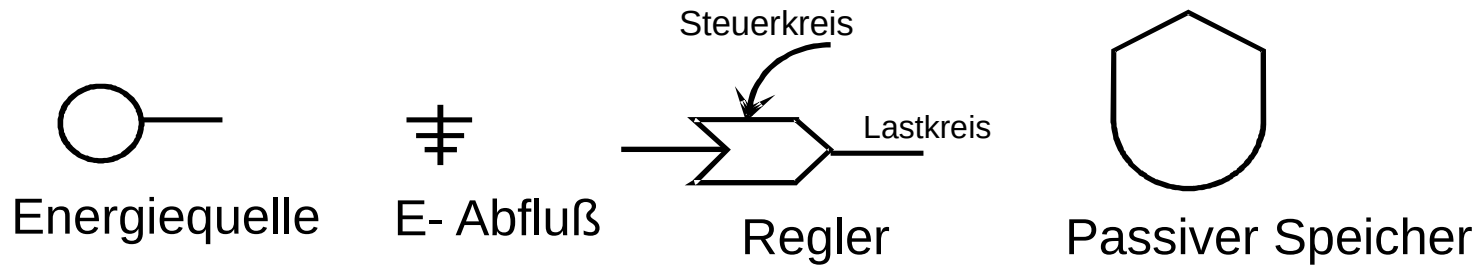
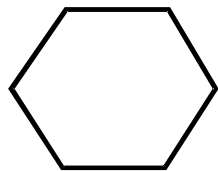

FIG. 9. A model of trophic interactions among plants, substrates, microflora, and fauna in a shortgrass prairie. (From Hunt *et al.* unpubl.)

Formelsprache für Ökosysteme mit Symbolen



Produzent



Konsument



Xorg....organisch geb. N/C

Xmin....remineralisierter N/C

POM....particulate org. matter

DOM....dissolved org. matter

Physiotypes / Ecotypes

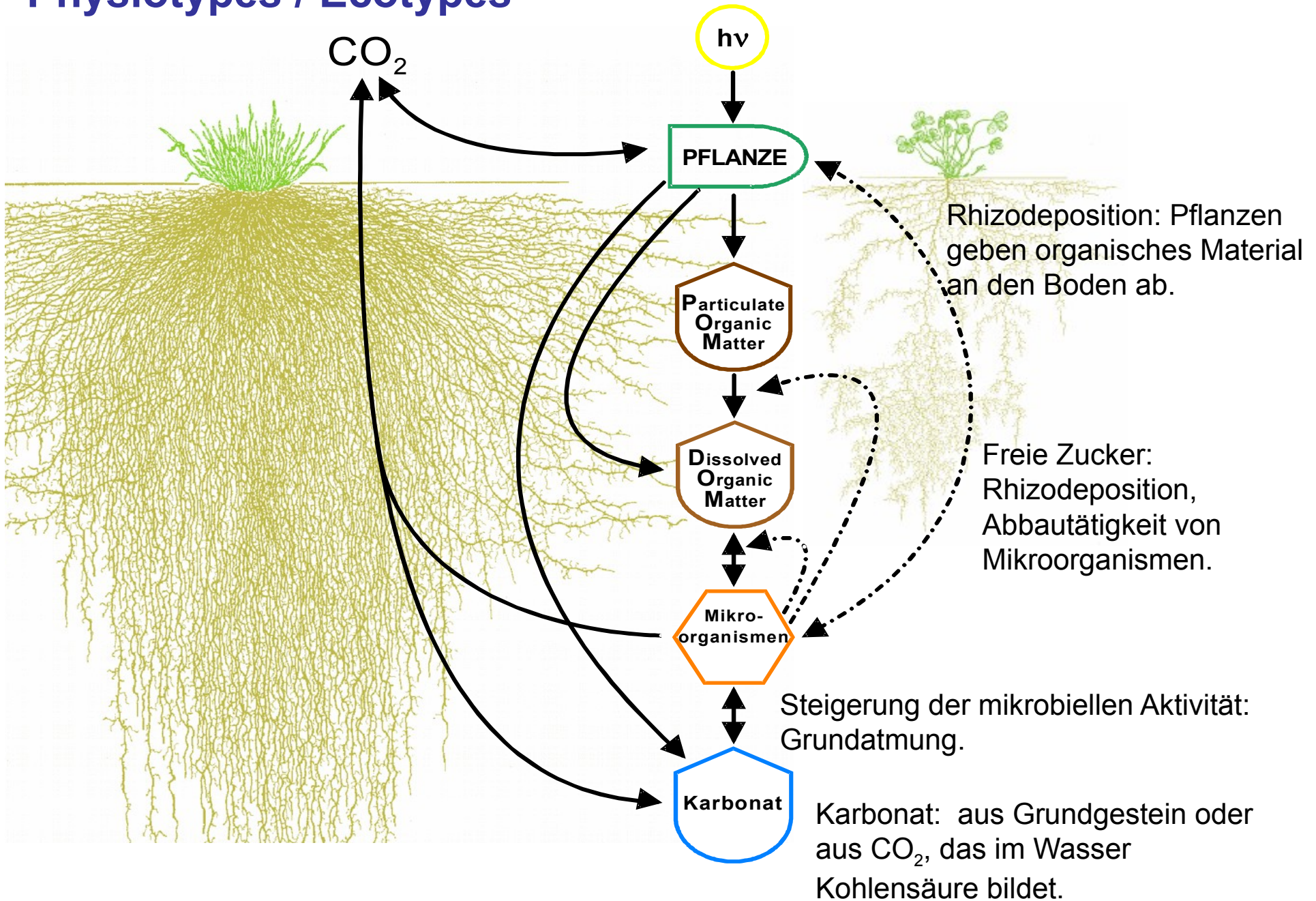

Rhizosphere

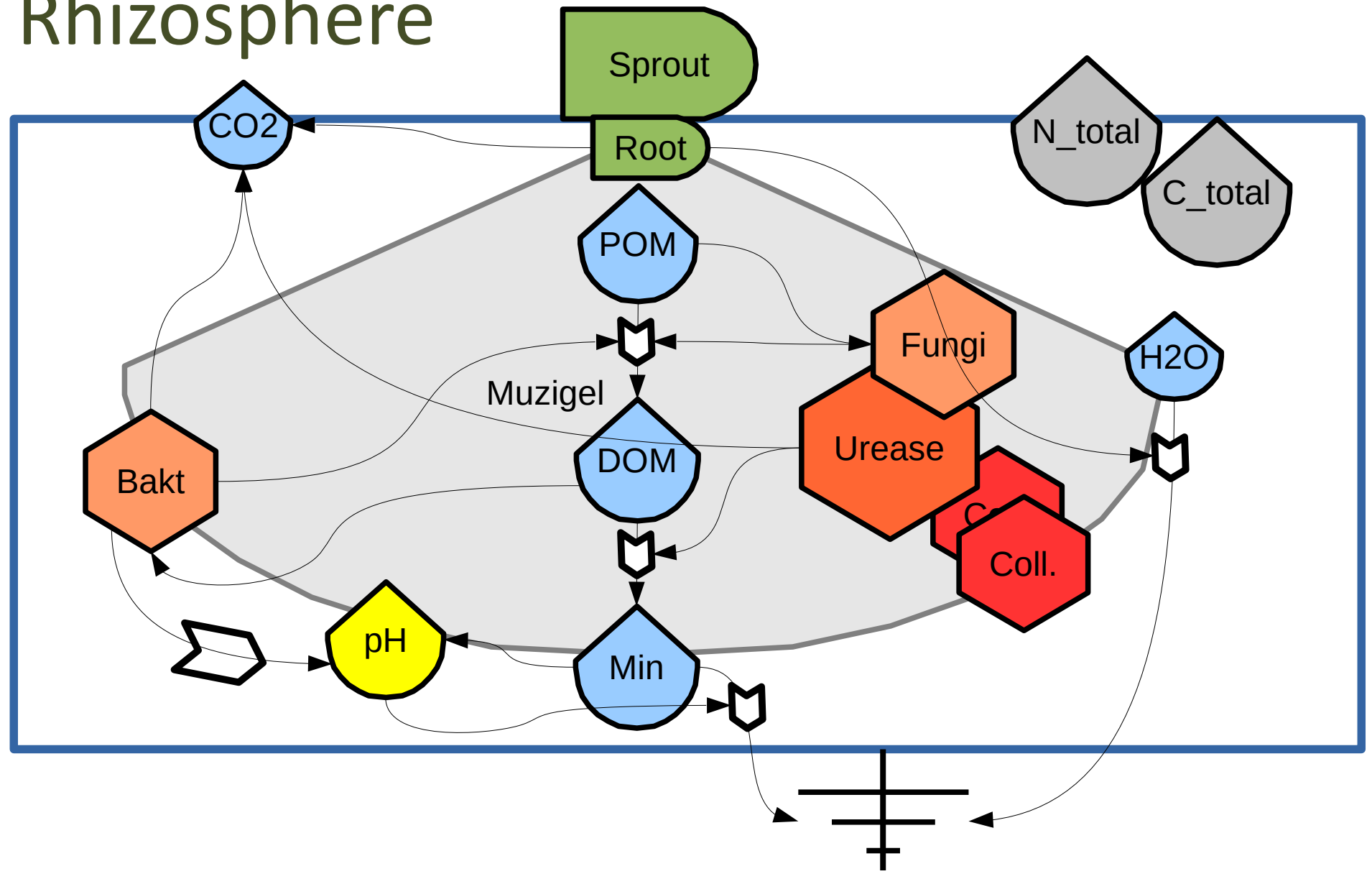

- Die Rhizosphäre
- Trophische Beziehungen
- **Ressourcenmanagement**

Ecological Pyramid

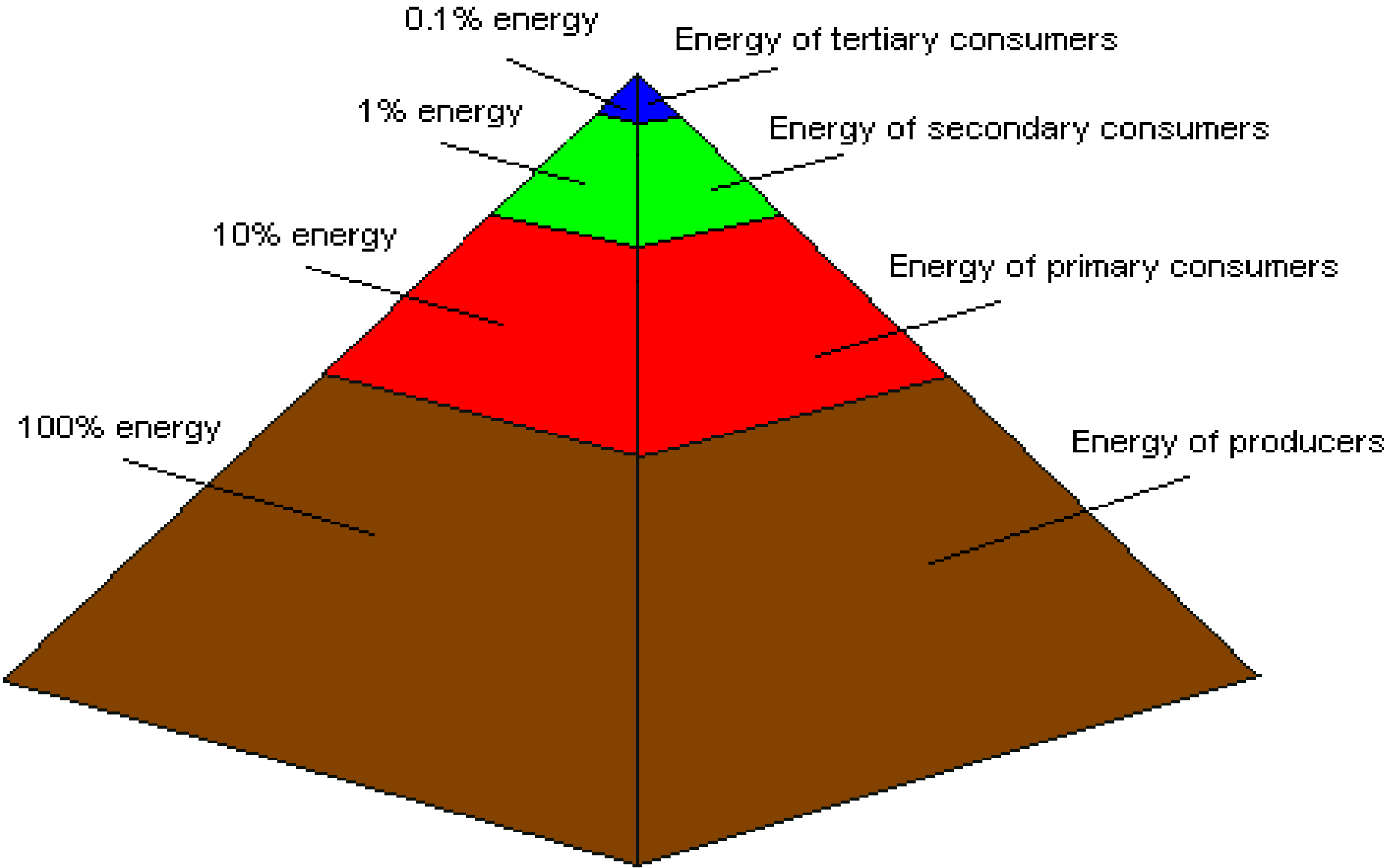

Energy Pyramid

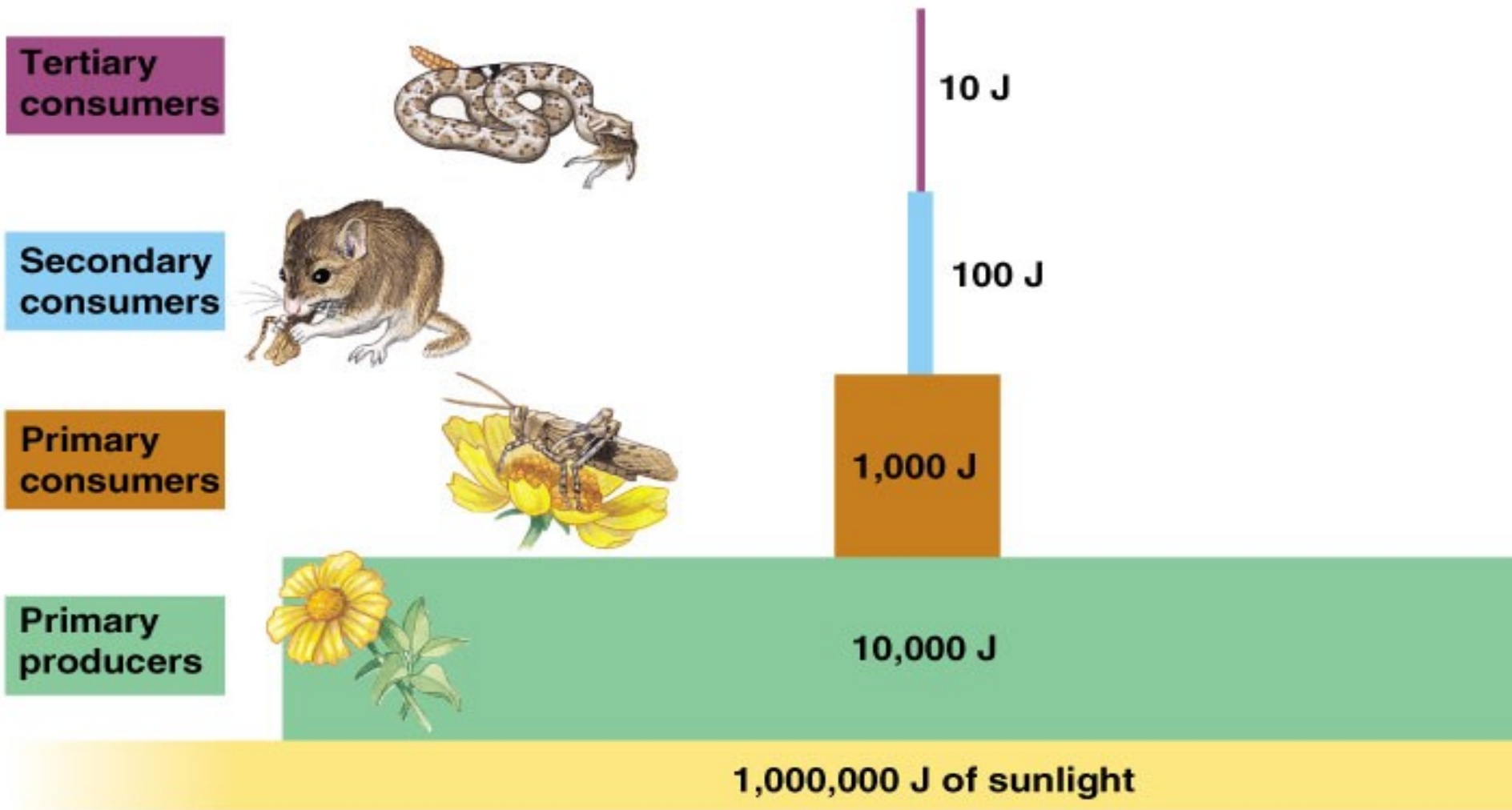

Apparatus to study the quantitative relationships between root exudates and microbial populations in the rhizosphere

R. MARTENS*

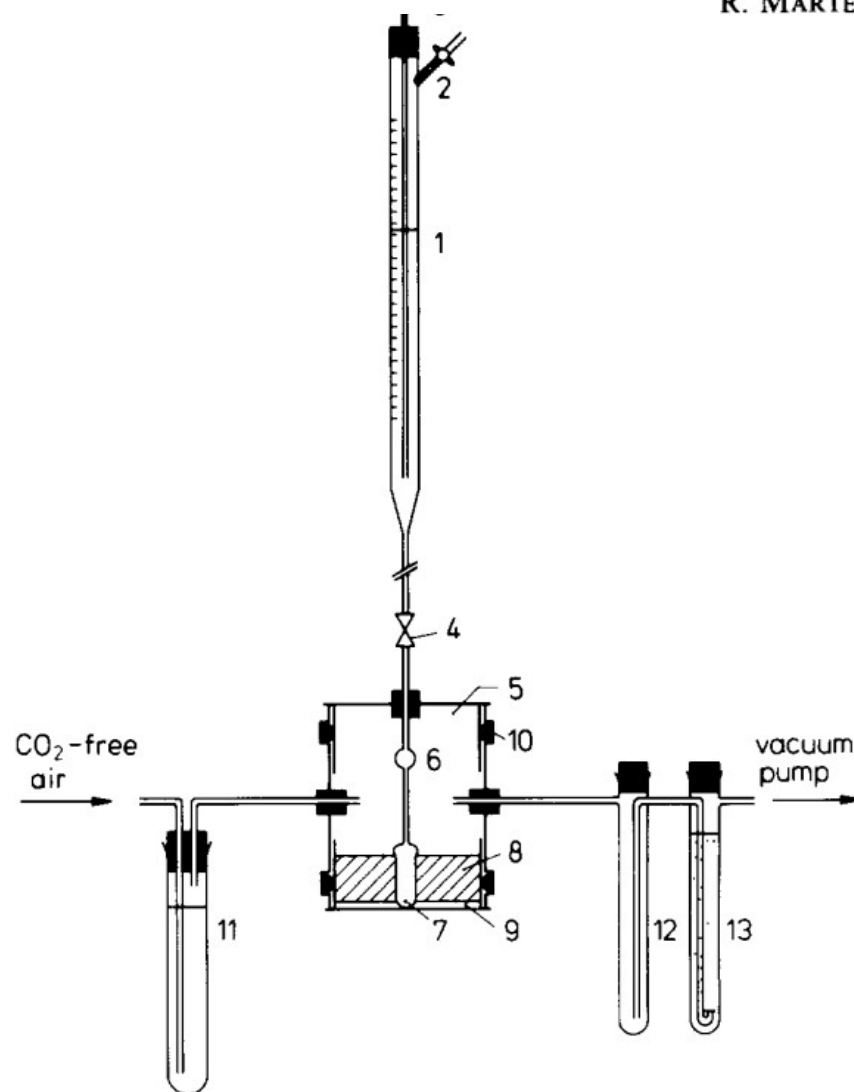

Fig. 1. Diagram of the apparatus. 1. Reservoir for artificial exudate; Connection to vacuum pump; 3. Inner glass tube; 4. Magnetic valve; 5. Incubation chamber; 6. Tygon tube and glass bulb; 7. Molecular filter; 8. Soil; 9. Plastic disc; 10. Greased rubber rings; 11. Tube with water; 12. Trap to prevent return flow; 13. CO₂-trap filled with ethanolamin and methanol or NaOH.

Table 1. Formation of microbial biomass ($\mu\text{g } ^{14}\text{C}$) from ^{14}C -labelled glucose added to soils during a 10-day period in an apparatus to measure quantitative aspects of the rhizosphere

Distance of soil from surface of membrane (mm)	Amount of ^{14}C -glucose ($\mu\text{g C } 10 \text{ days}^{-1}$) added to soil					
	880		4400		22,000	
	A ^a	B ^b	A	B	A	B
0-2	54	81	226	262	382	325
2-4	1.5	7	34	49	271	327
4-6	0.4	0.6	3	6	30	126
6-8	0.6	0.5	1.1	1.5	5	26
8-10	0.2	0.4	1.0	1.9	8	6
10-14	0.3	0.5	1.3	2	10	8
14-19	0.3	0.7	1.5	3	12	13
19-52	3	6	13	24	89	96
Total in soil	60.3	96.7	280.7	349.2	807	927
CO ₂ - ^{14}C (μg) respired	479	529	2516	2455	14,366	13,860
Biomass ^{14}C as a percentage of ^{14}C added to soil	6.9	11.0	6.4	7.9	3.9	4.3

^aArable soil from the north east of Scotland (Sand 74%, silt 19%, clay 7%; org. C 5.3%; pH 10 mM CaCl₂ 4.7).

^bArable soil from the eastern parts of West-Germany (Sand 43%, silt 51%, clay 6%; org. C 1.2%; pH 10 mM CaCl₂ 5.3).

A remarkable result of all experiments was the very low efficiency by which the microbial population used the available carbon source for its own proliferation. Between 54 and 65% of the added carbon was respired as CO₂ and only 4 to 11% was transformed into microbial biomass.

Description of Sustainability

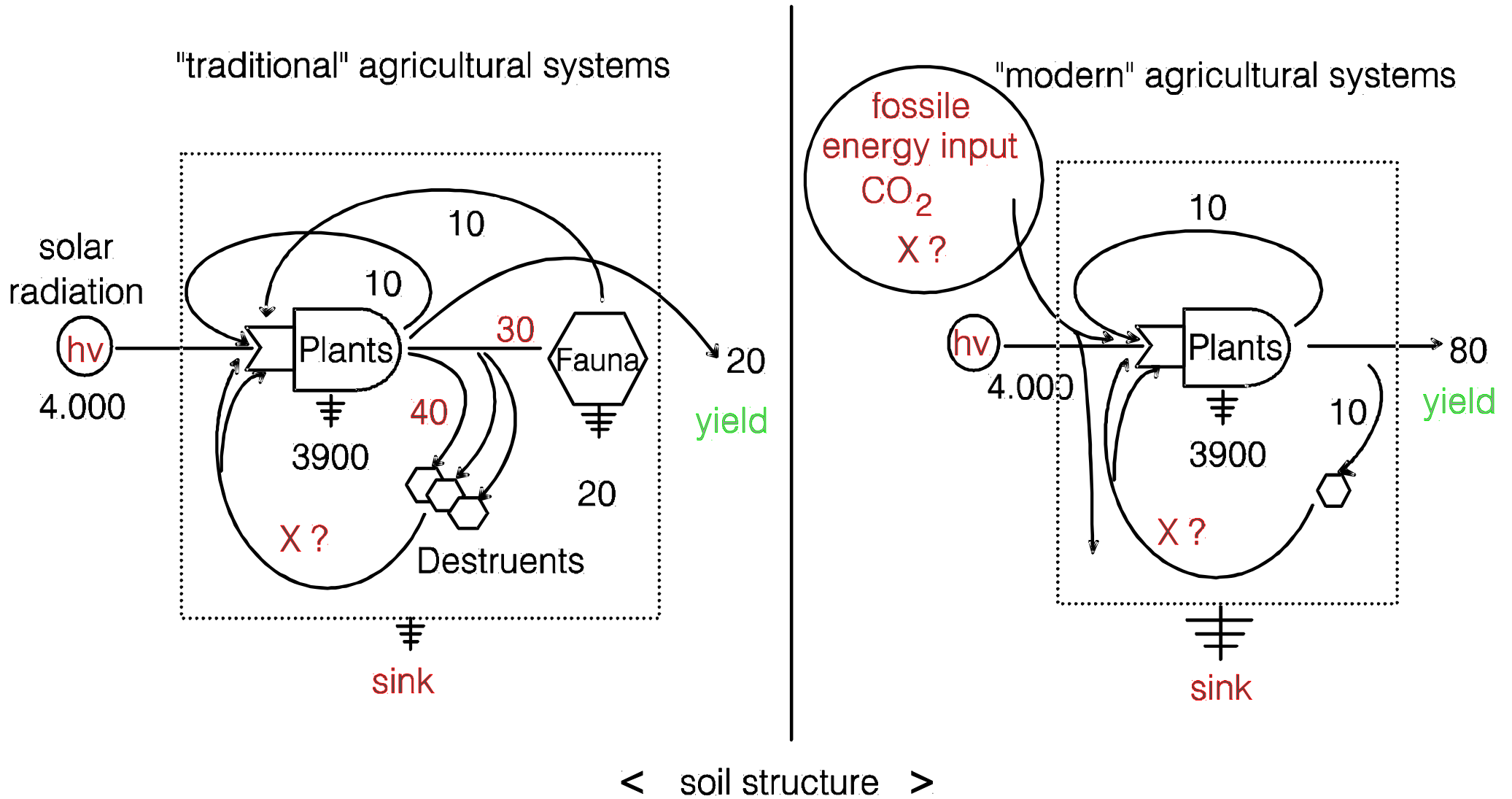

energy balance in agriculturally used systems (after H.T.Odum, 1971).

Liebig's law of the minimum

Liebig's law of the minimum, often simply called Liebig's law or the law of the minimum, is a principle developed in agricultural science by Carl Sprengel (1828) and later popularized by Justus von Liebig.

It states that growth is controlled not by the total amount of resources available, but by the scarcest resource (limiting factor).

https://en.wikipedia.org/wiki/Liebig%27s_law_of_the_minimum

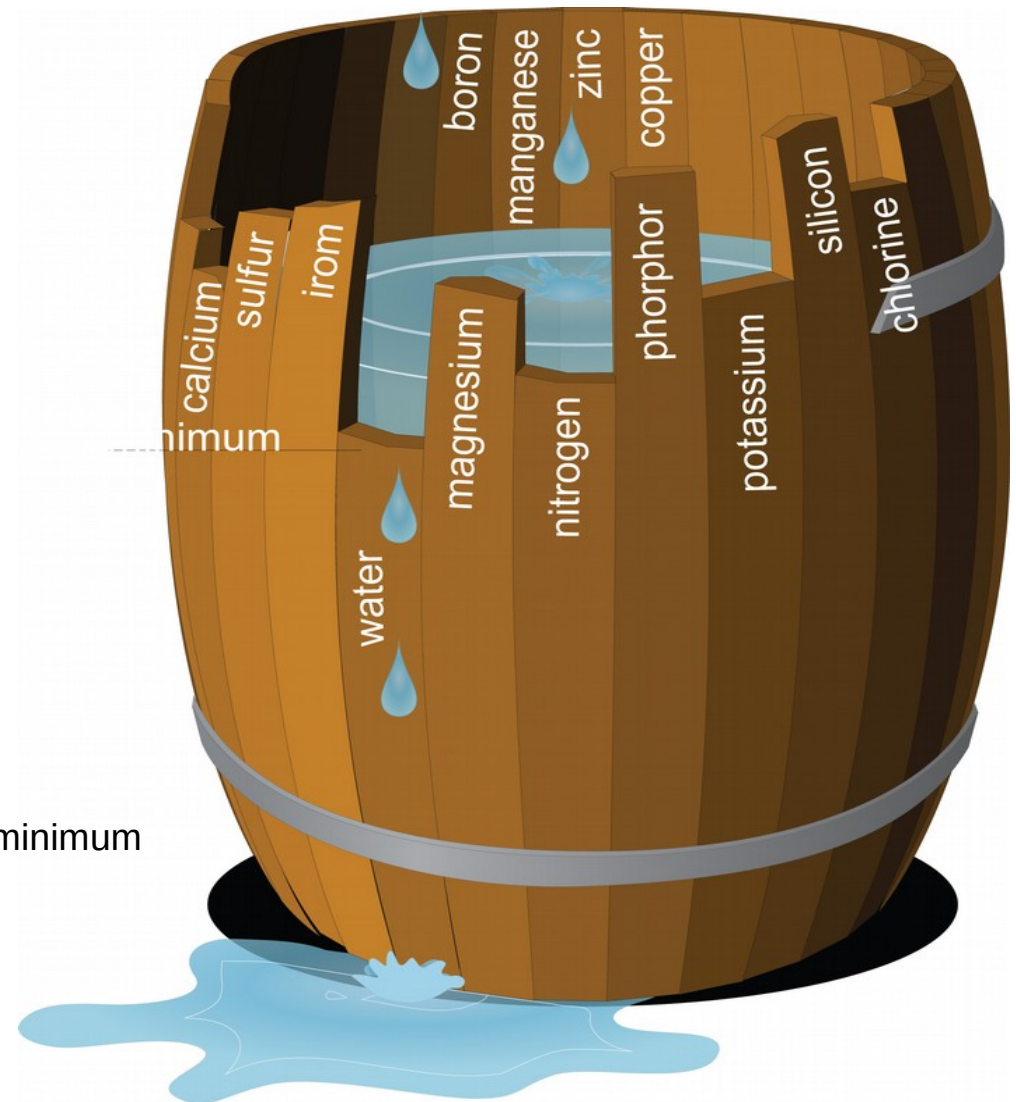

Verfügbarkeit
Limitierung
Immobilisierung
Streß
Hormesis



Verfügbarkeit
Limitierung
Immobilisierung
Streß
Hormesis

